

BLANKE

NEW YORK EDITION

Colors and textured finishes for creative, design-oriented options





**CLASSIC, CONTEMPORARY
OR AVANT-GARDE**

Dive into a world of endless design potential – with our **NEW YORK EDITION** colors! The floor and wall profiles are available in all colors and textured finishes. But that's not all - discover many of our products in all the powder-coated colors that the **BLANKE NEW YORK EDITION** has to offer. This opens up exclusive design possibilities. Match the Blanke products to your favorite tile. Design your bathroom elegantly tone-in-tone or set exciting accents. Discover our products in stock or request your individual offer now!

ALL COLOURS IN STOCK



Trims

(A, B)

- > BLANKE CUBELINE
- > BLANKE EDGE PROTECTOR TRIM

ALL COLOURS IN STOCK



Shelves

(B)

- > BLANKE ECKBERT

AVAILABLE ON REQUEST



Drainage systems

(B)

- > GRATE COVER 2.0 FRAMELESS

AVAILABLE ON REQUEST

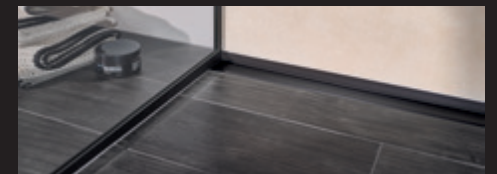

Slope and shower profiles

(B)

- > BLANKE AQUA-KEIL
- > BLANKE AQUA-KEIL WALL
- > BLANKE AQUA-KEIL GLASS
- > BLANKE AQUA-GLASS
- > BLANKE AQUA-DEKO

ANODIZED (A)



Silver



Silver, cross brushed



Matt Gold



Matt Bronze



Black



Titanium

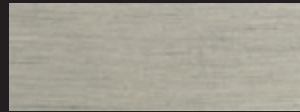

Champagne

POWDER-COATED (B)

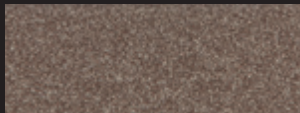

Sand Tropez

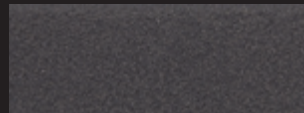

Graphit



Industrial Rust

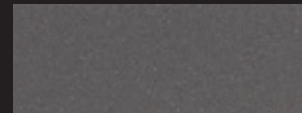

Stone Gray



Coal Black

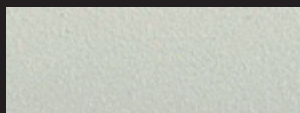

Oyster White

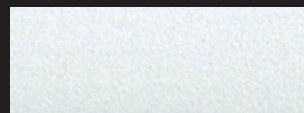

Sugar White

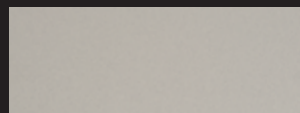

Moonstone

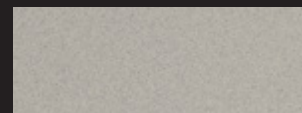

Greige

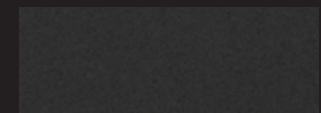

Midnight Black



Urban Grey

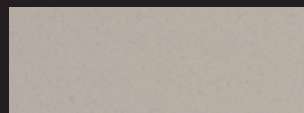

Cotton



Smoke

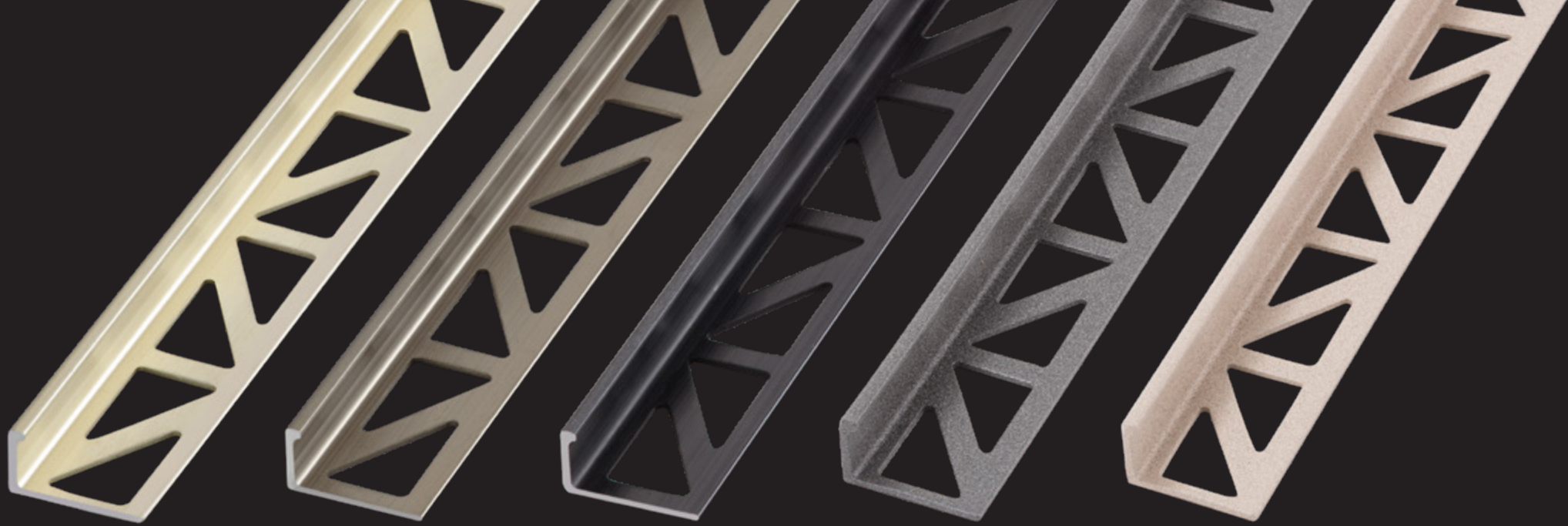

Champagne

Titanium

Black

Smoke

Greige

> Selected sample colors are shown. An overview of all NEW YORK EDITION colors can be found at the beginning of this brochure.

BLANKE EDGE PROTECTOR TRIMS are the professional solution to protect tile edges against mechanical damage, in places where it is not possible to guarantee clean edges or corner finishes as well as purely for decorative purposes. Find the BLANKE NEW YORK EDITION color that matches your tile to perfect the overall appearance of the tiled room.

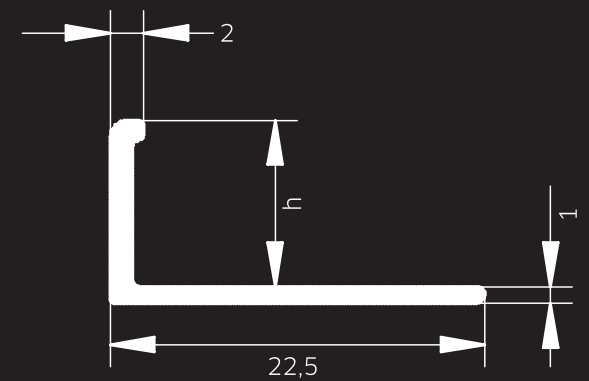

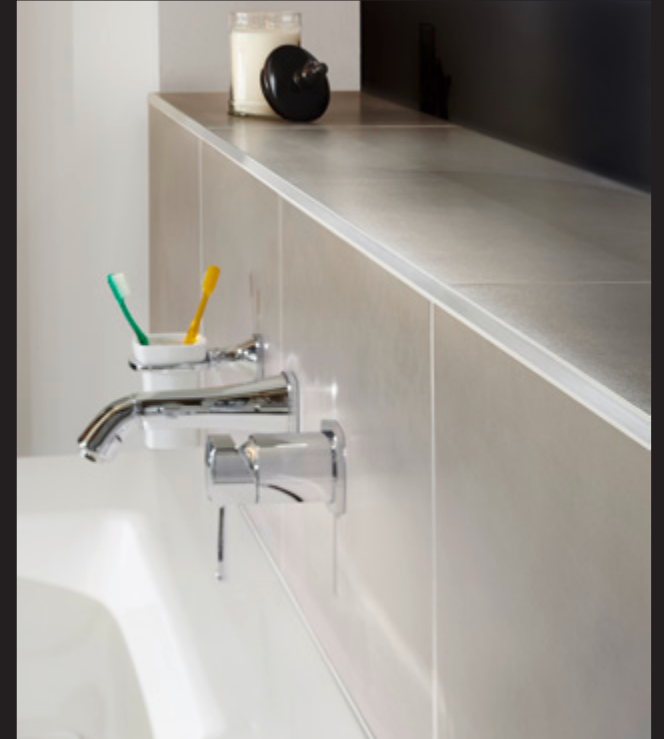

**BLANKE
EDGE PROTECTOR TRIM**



**BLANKE
CUBELINE**

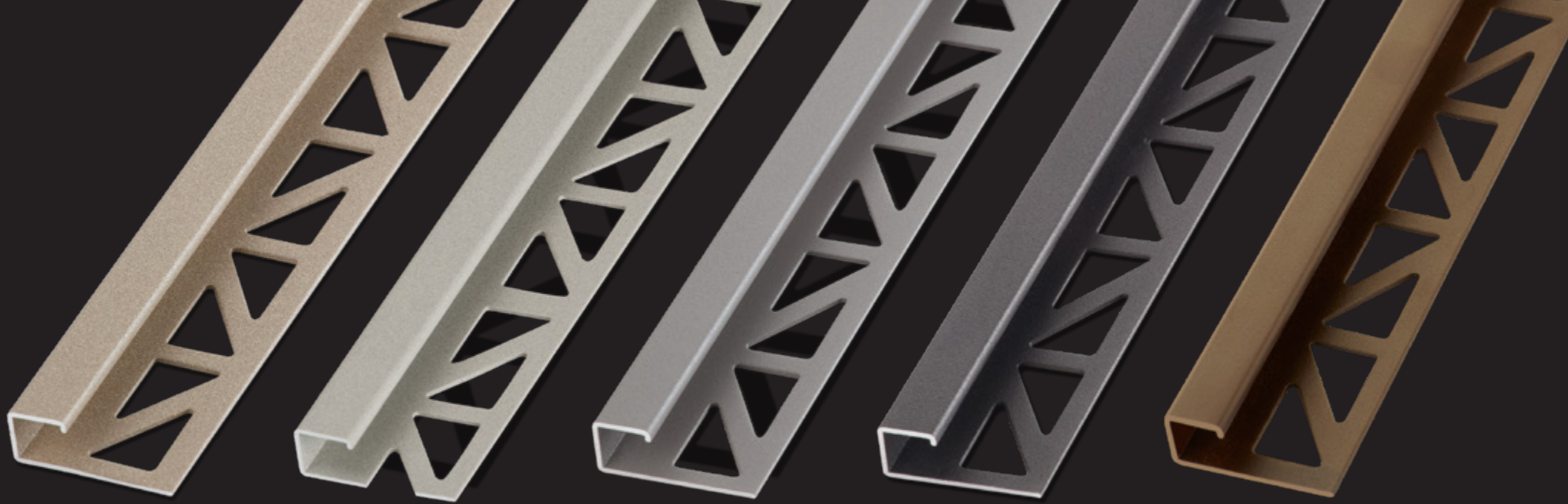

Sand Tropez

Moonstone

Stone Gray

Graphit

Industrial Rust

> Selected sample colors are shown. An overview of all NEW YORK EDITION colors can be found at the beginning of this brochure.

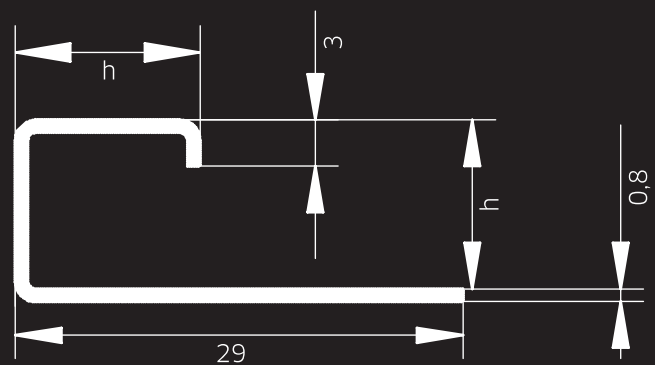

BLANKE CUBELINE is a novel edge protector for corner solutions on tiled surfaces. The highlight is the unusually decorative visual effects at corners, where the individual, visible surfaces of the profile sides are, in contrast to traditional edge protectors, perfectly right-angled and symmetrical by design. The various designs of the BLANKE NEW YORK EDITION allow optimal and decorative adaptation to a wide variety of tile and joint colors. BLANKE CUBELINE also protects the edge of the tile.

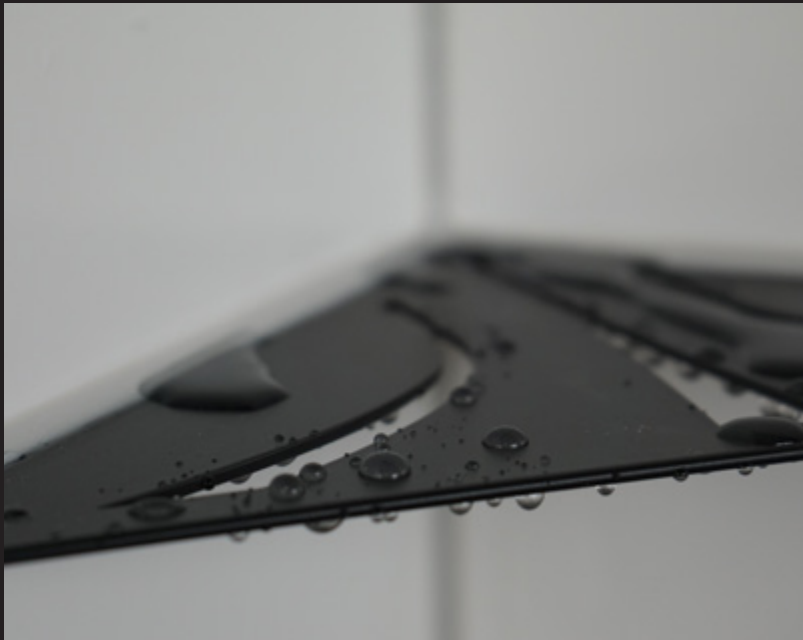

BLANKE ECKBERT

BLANKE ECKBERT is a useful corner shelf for the modern shower area. Shampoo and shower gel bottles find their place here. The shelf is made of sturdy stainless steel and can also be subsequently inserted into the grouting without drilling any holes. The different design variants KASKA, QUELL, XL KASKA and XL QUELL as well as the additional powder-coated colors of the BLANKE NEW YORK EDITION, make the ECKBERT shelf not only useful, but also a particularly design-oriented sight.



Sand Tropez



Midnight black



Cotton



Urban Grey

> Selected sample colors are shown. An overview of all NEW YORK EDITION colors can be found at the beginning of this brochure.



BLANKE AQUA-PROFILE

BLANKE AQUA-GLASS

BLANKE AQUA-DEKO

BLANKE AQUA-KEIL GLASS

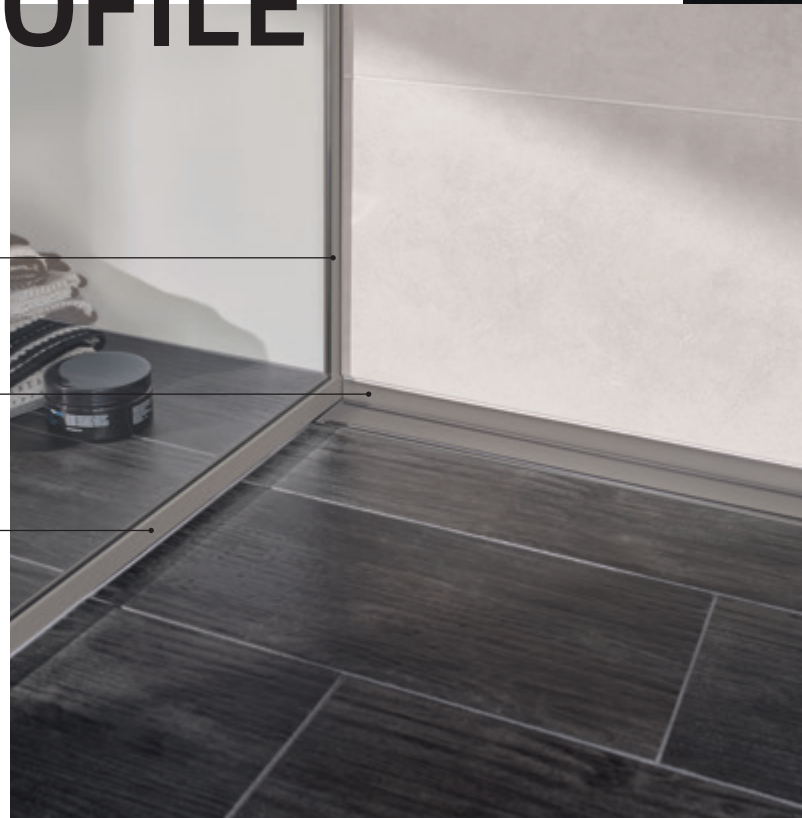

Only available upon request

> Selected sample colors are shown. An overview of all NEW YORK EDITION colors can be found at the beginning of this brochure.





Walk-in showers form the cornerstone of modern bathroom design and also impress with their accessibility.

The level-access showers can be installed quickly and easily with the AQUA profiles from Blanke. Thanks to their design, the shower profiles create a gradient of 2%, eliminating the necessity to cut tile to size. In the modern colors of the BLANKE NEW YORK EDITION, they are also a real eye-catcher!



We're not
scientists,
but we totally
got space.

Specialized storage
for your business
and home.

Manhattan
Self Storage

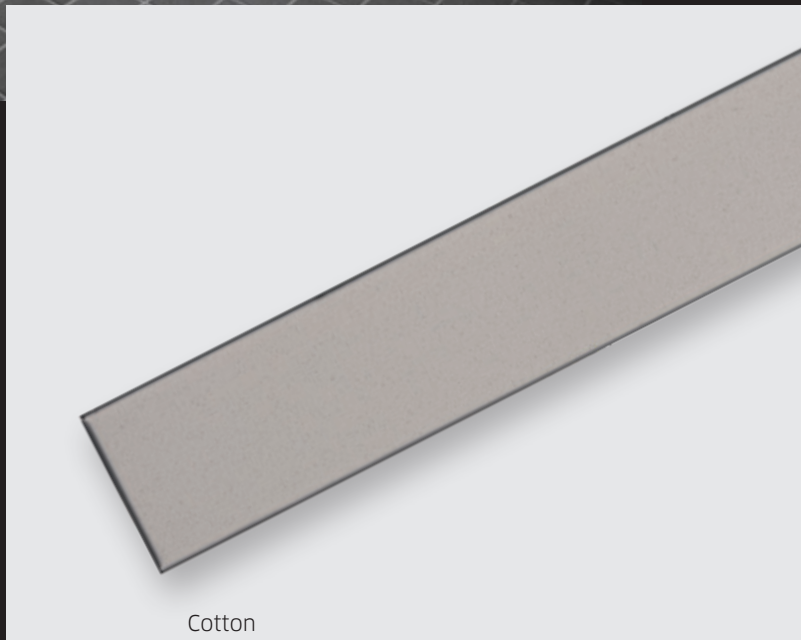
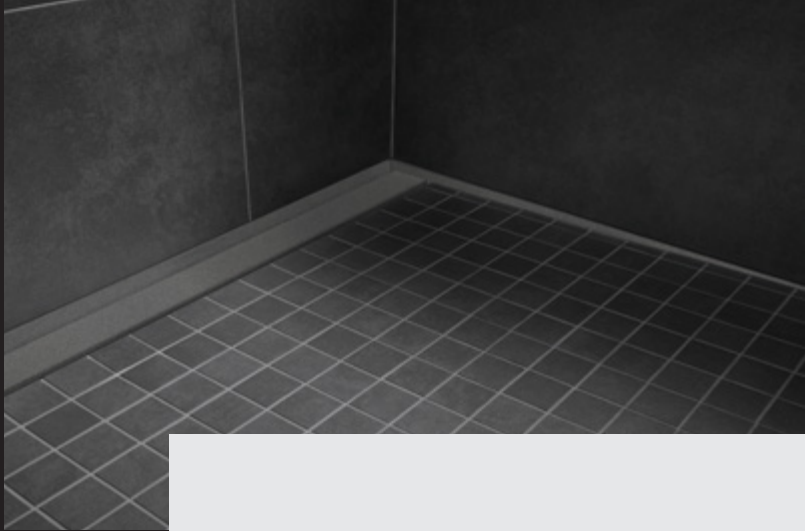

Cotton

Only available upon request

BLANKE GRATE COVERS 2.0 FRAMELESS

The frameless GRATE COVERS 2.0 are available in two different designs: brushed and tileable. The covers for use with Blanke DISK-LINE and BLANKE DIBA-LINE 2.0 are made of high-quality stainless steel; available in lengths of 60, 70, 80, 90, 100, 110 and 120 cm. In the powder-coated colors of the BLANKE NEW YORK EDITION, they form the visual highlight in your walk-in shower.

> Selected sample colors are shown. An overview of all NEW YORK EDITION colors can be found at the beginning of this brochure.





Consultation and sales:

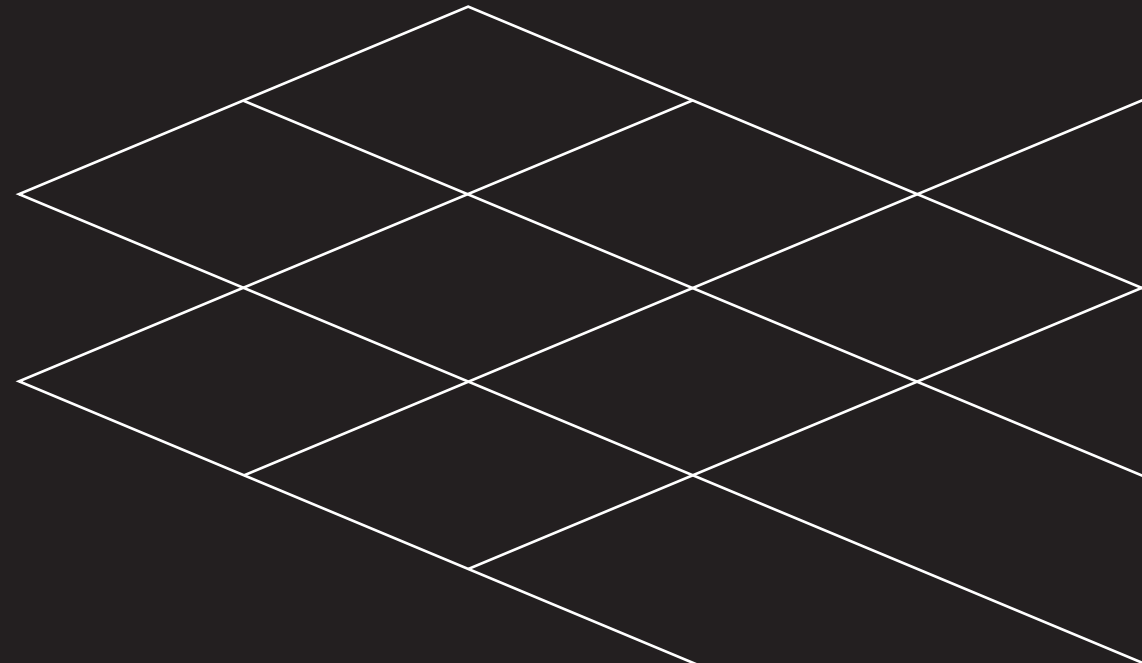

Blanke Systems GmbH & Co. KG
Stenglingser Weg 68-70
58642 Iserlohn/Germany
T +49 (0)2374 507-0
E info@blanke-systems.de
I www.blanke-systems.com